

Van Cleef & Arpels

Movimento al quarzo con corone

1. Lettura dell'ora

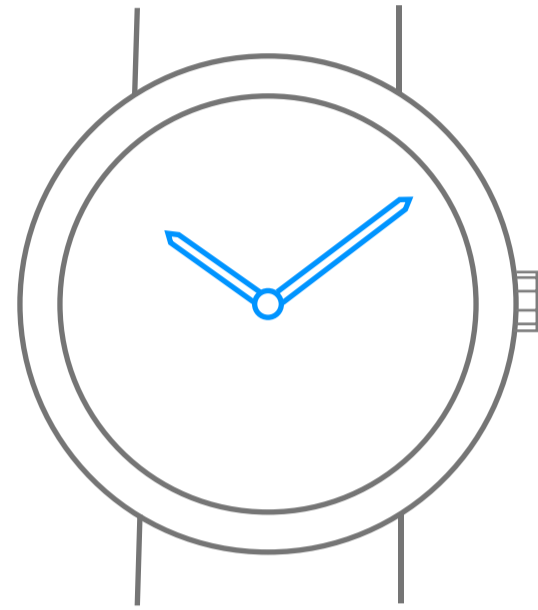

10 : 10

2. Impostazione dell'ora

1.

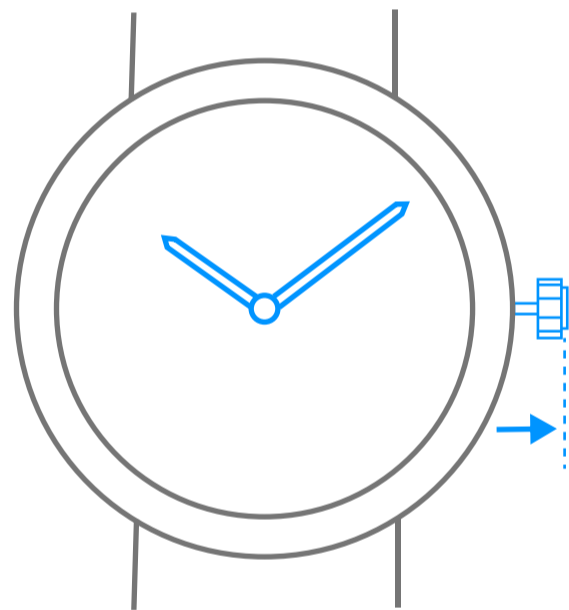

10 : 10

2.

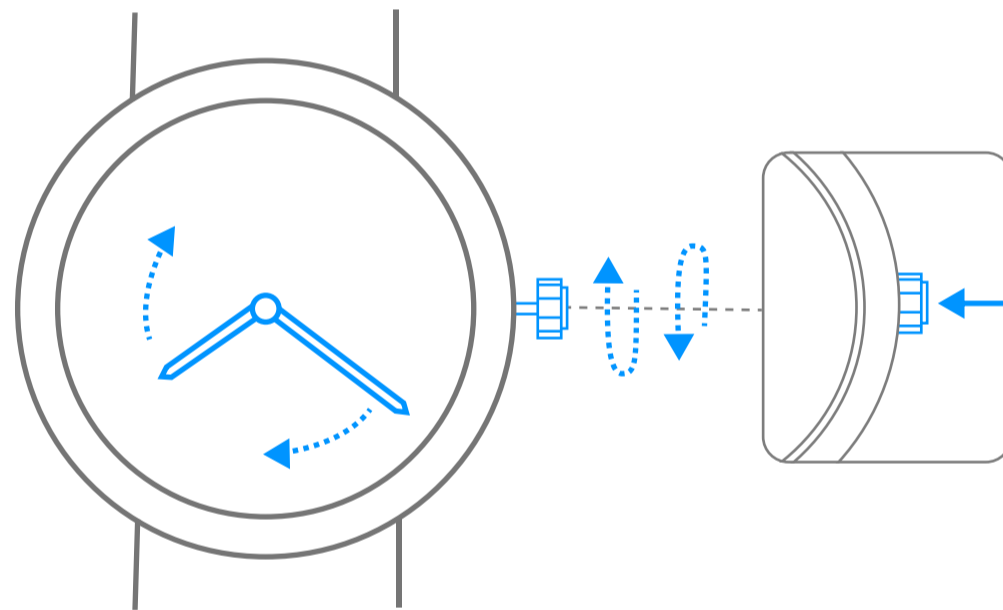

08 : 20

1.

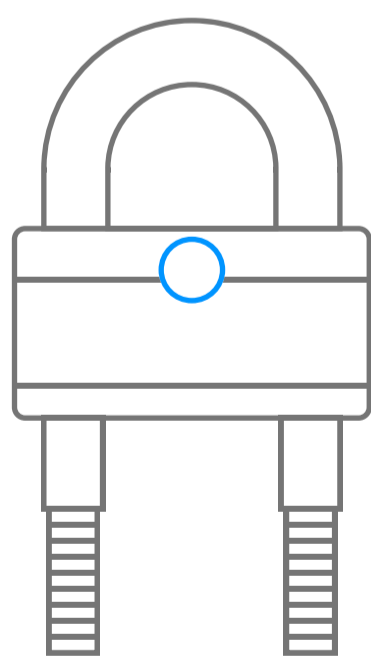

2.

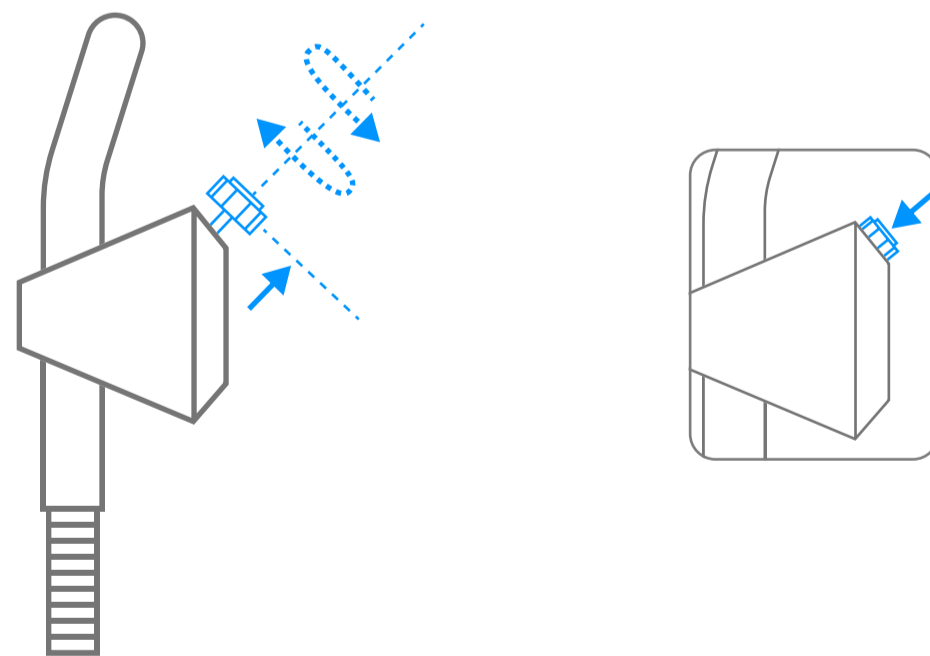

Van Cleef & Arpels

Pittogrammi

00h
AUTONOMIA

Riserva di carica dell'orologio



Attenzione, attendere 30 secondi tra la carica dell'orologio e l'impostazione dell'ora

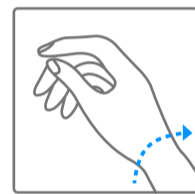

Carica automatica grazie ai movimenti del polso



Ruotare in senso orario

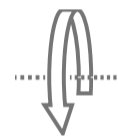

Ruotare in senso antiorario

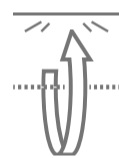

Ruotare in senso orario fino a sentire resistenza

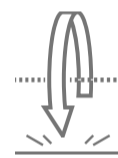

Ruotare in senso antiorario fino a sentire resistenza



ORA LOCALE

Ora locale



2nd TIME ZONE

Ora del paese selezionato



Suono acuto



Suono grave